

COMPONENTS
1.33x ACTUAL SIZE
NUMBERING PER
FACTORY SCHEMATIC

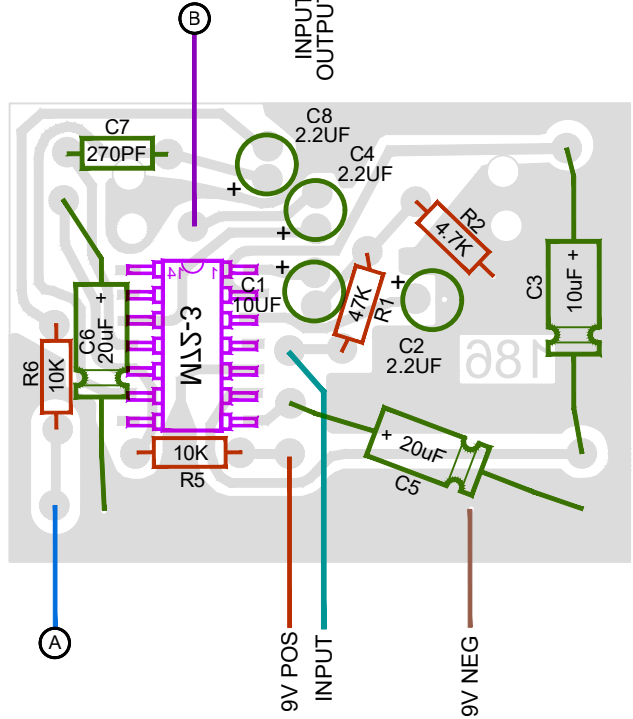

BOTTOM OF PCB
ACTUAL SIZE

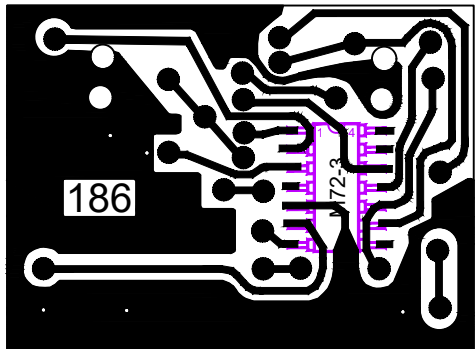

NOTE: IC CHIP IS
MOUNTED ON BOTTOM
OF CIRCUIT BOARD

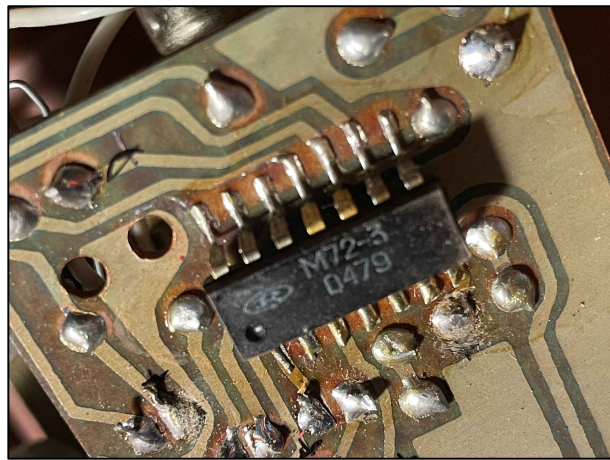
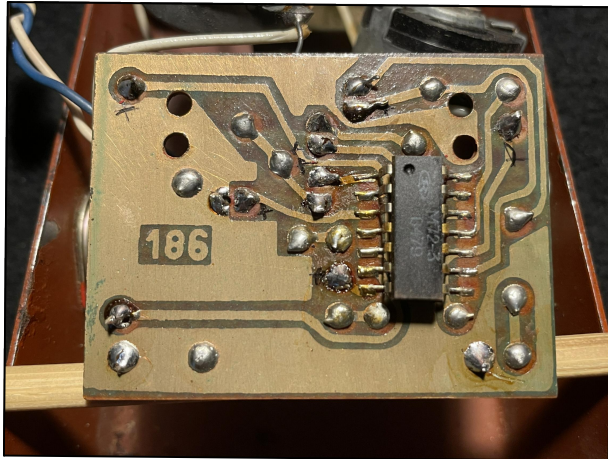
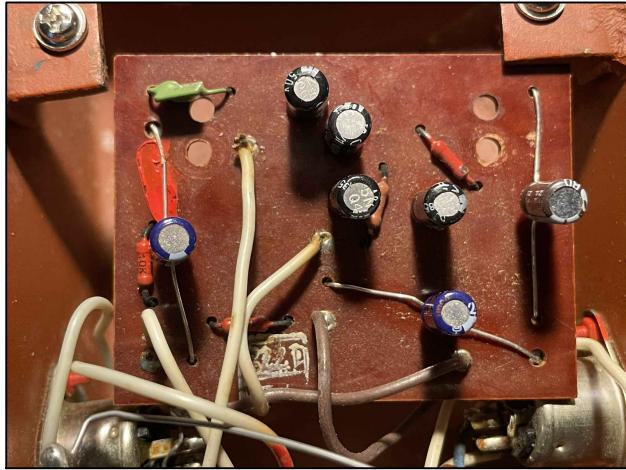

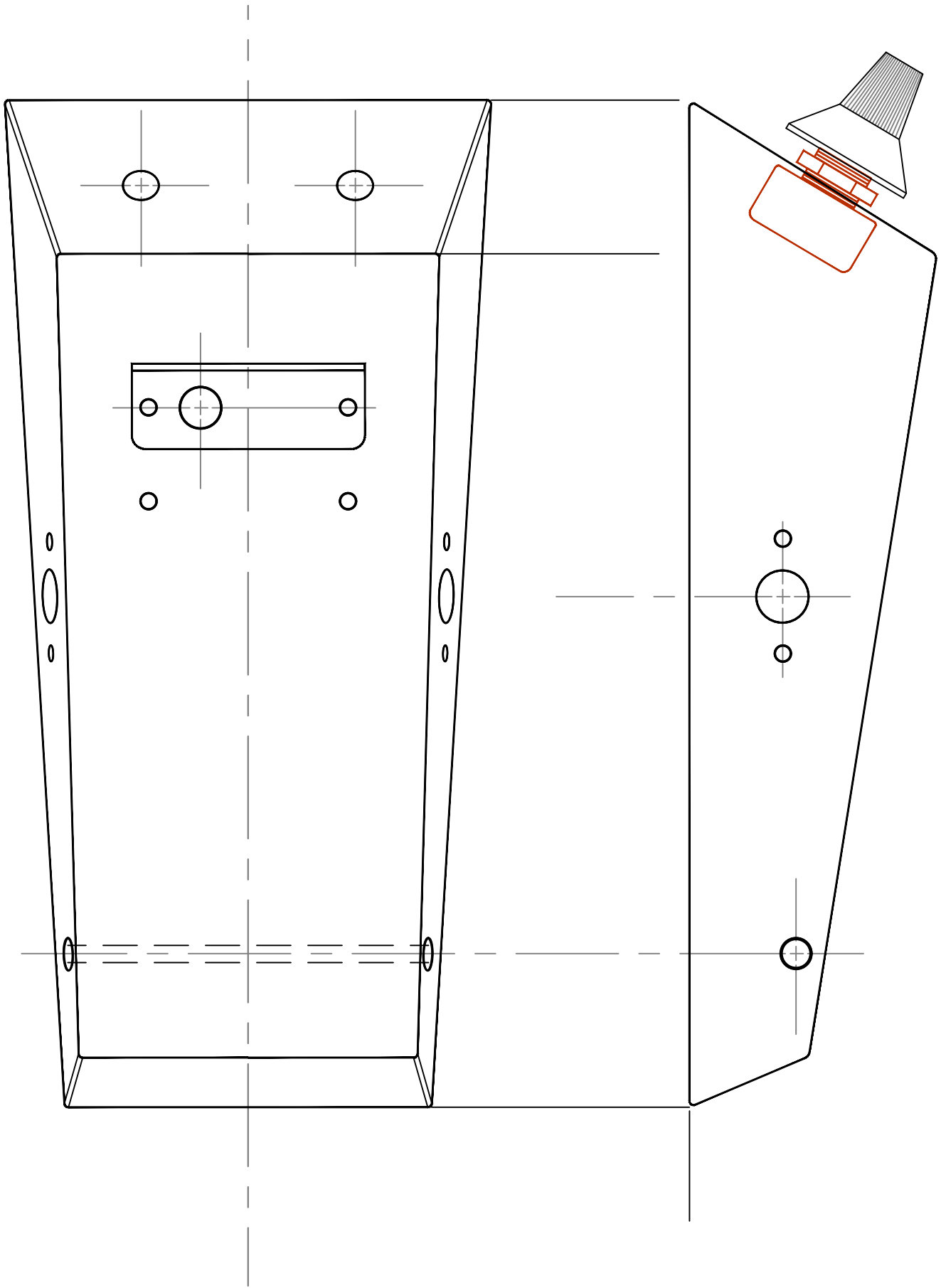

TOP VIEW

SIDE VIEW

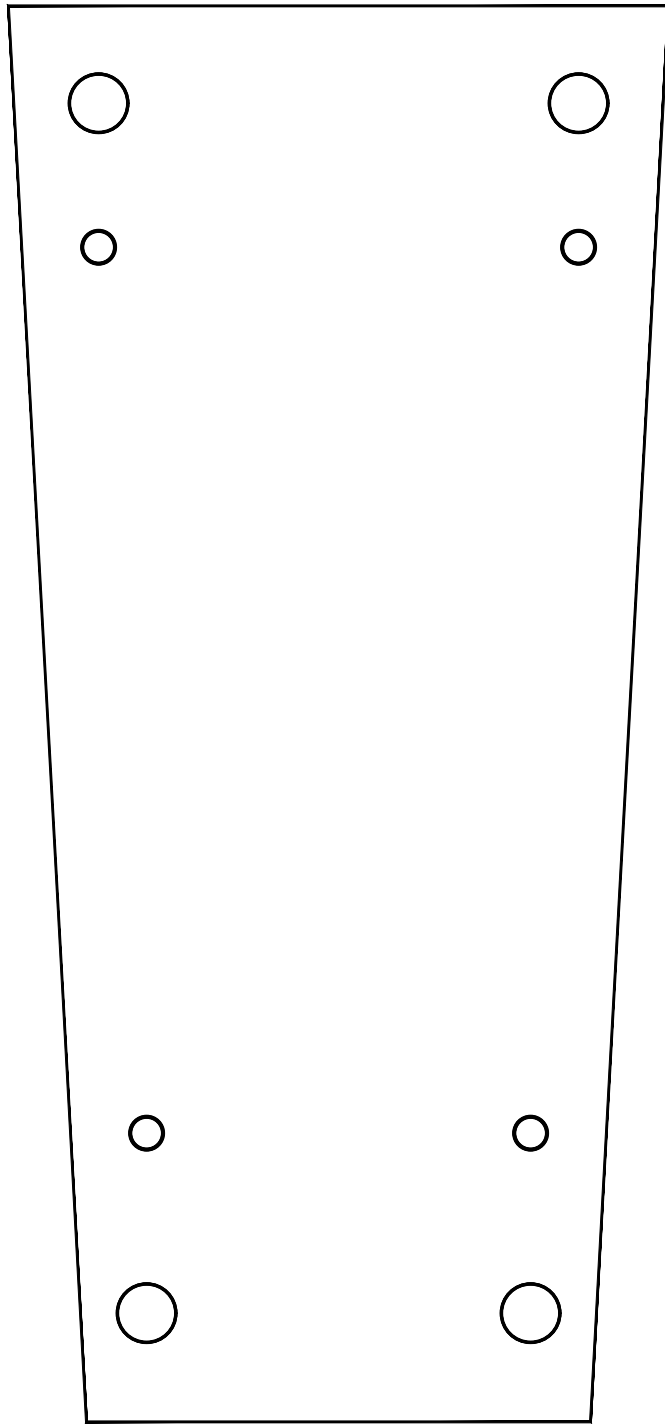

BOTTOM COVER

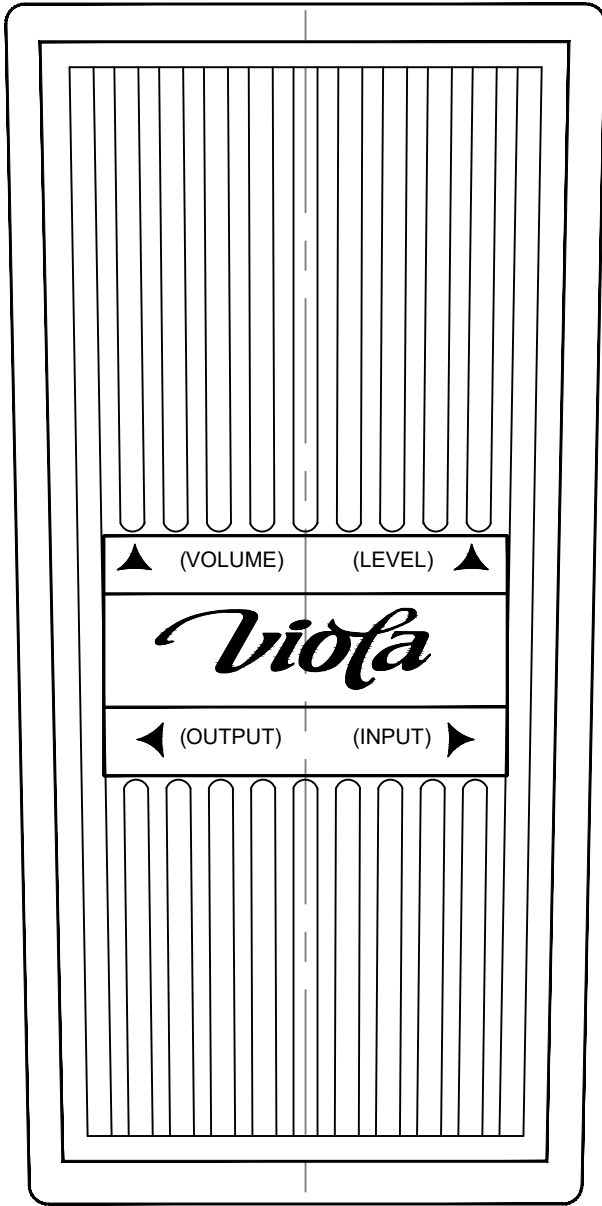

TREADLE
TOP VIEW

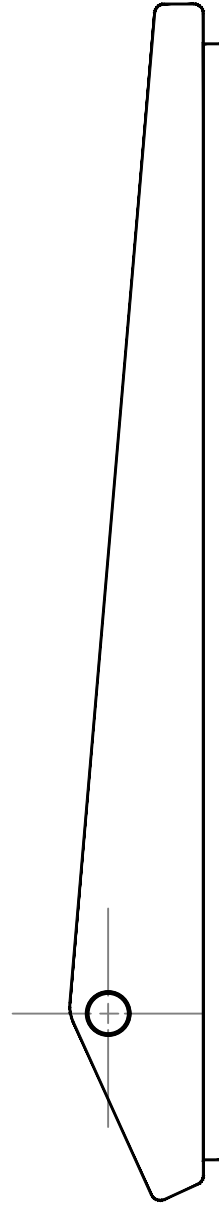

TREADLE
SIDE VIEW

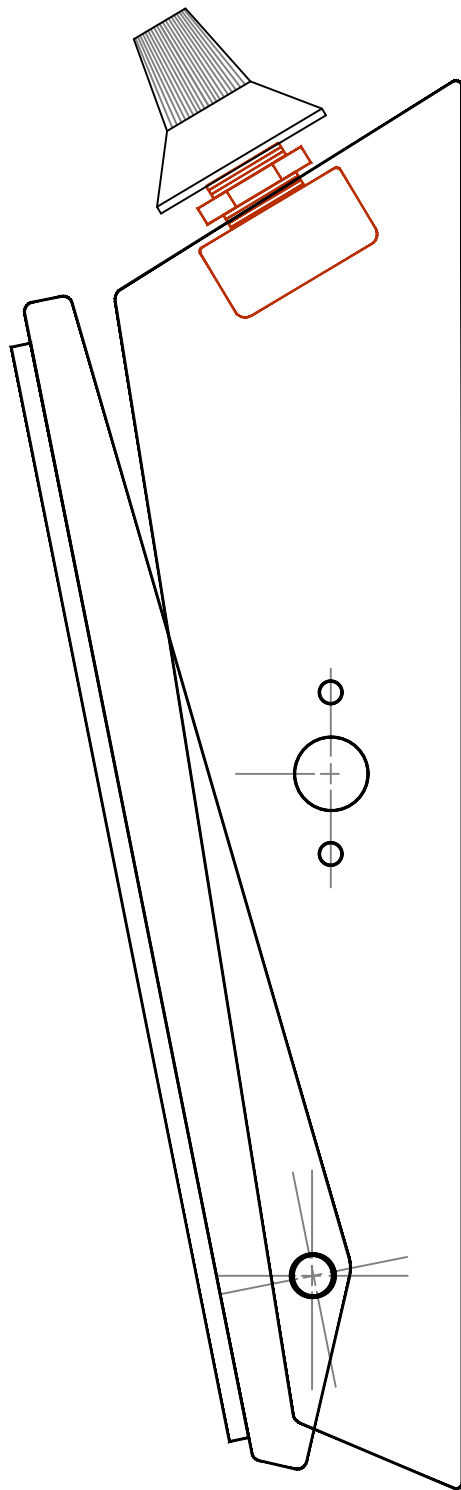

SIDE VIEW
FULL SIZE